

PROJECT	
TYPE	
SPECIFIER	
QUANTITY	
DATE	

## SPARKS DOUBLE HEAD SURFACE

### D103134-

base number                      Finish                       
Options                     

- To build a product code in our configurator select the specify button on the base model # product page
- To build a manual product code on this datasheet choose from the options listed below in blue font and add the suffix to the base model #

#### GENERAL

Series: Sparks                       
 Subseries: Sparks Double Head                       
 Brand: Quasar                       
 Division: Design                       
 Mounting Type: Surface                       
 Mounting Location: Wall                       
 Subcategory: Ambient                     

#### PHYSICAL

Shape: Abstract                       
 Length (mm): 225                       
 Length (in): 8 7/8                       
 Height (mm): 330                       
 Depth (mm): 190                       
 Height (in): 13                       
 Depth (in): 7 1/2                       
 Light Distribution: Omnidirectional                       
 Weight (kg): 3                       
 Weight (lbs): 6.6                       
 Fixture Finish: WHI / PAL                       
 Fixture Material: Metal                     

#### ELECTRICAL

Lamp Type: LED                       
 Input Wattage (W): 4.2                       
 Total Output Wattage (W): 3.2                       
 Dimming: Non-Dimmable                       
 Driver Included: Yes                       
 Driver Location: Integrated                       
 Driver Type: Constant Current - Universal                       
 Driver Class: Class 2                       
 Input Voltage (V): 120 - 277                       
 Constant Current (MA): 350                       
 Upon Request: (Not included - see components) Remote: 0-10Vdc dimming / Phase dimming @120Vac only                     

#### LED

Number of LEDs: 1                       
 Color Temperature (°K): 2700                       
 Max. Delivered Lumen (lm): 376                       
 CRI: >90 CRI                       
 Lamp Life (hrs): 50000                     

#### OPTICAL

#### RATINGS AND CERTIFICATIONS

Certified By: Certified for North American Standards                       
 IP rating: IP20                     

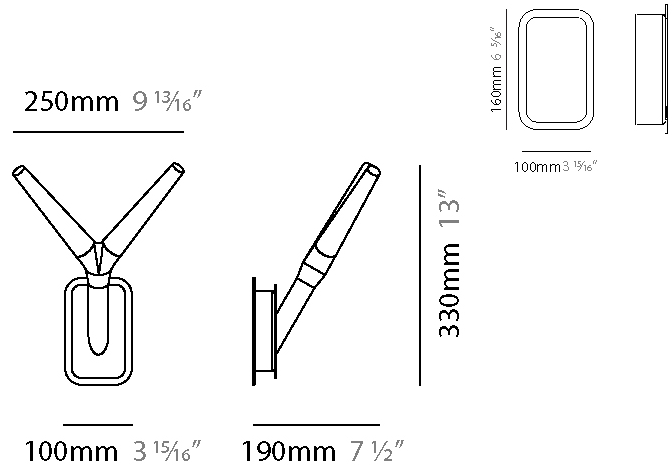

## SPARKS DOUBLE HEAD SURFACE

D103134-

PROJECT \_\_\_\_\_

TYPE \_\_\_\_\_

SPECIFIER \_\_\_\_\_

QUANTITY \_\_\_\_\_

DATE \_\_\_\_\_

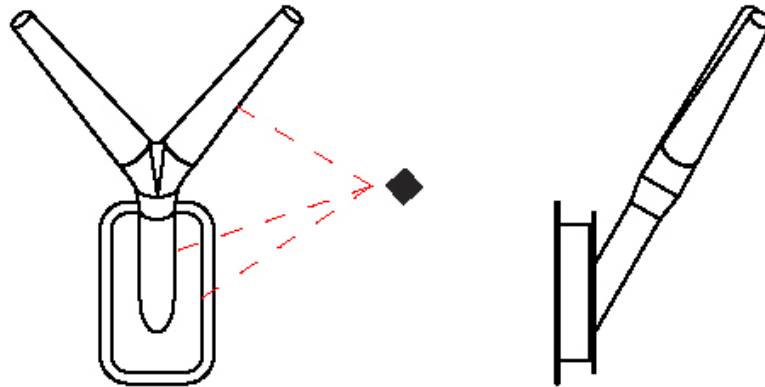

## SPARKS TRIPLE HEAD SURFACE

### D103136-

base number \_\_\_\_\_  
 Finish \_\_\_\_\_  
 Options \_\_\_\_\_

- To build a product code in our configurator select the specify button on the base model # product page
- To build a manual product code on this datasheet choose from the options listed below in blue font and add the suffix to the base model #

#### GENERAL

Series: Sparks \_\_\_\_\_  
 Subseries: Sparks Triple Head \_\_\_\_\_  
 Brand: Quasar \_\_\_\_\_  
 Division: Design \_\_\_\_\_  
 Mounting Type: Surface \_\_\_\_\_  
 Mounting Location: Wall \_\_\_\_\_  
 Subcategory: Ambient \_\_\_\_\_

#### PHYSICAL

Shape: Abstract \_\_\_\_\_  
 Length (mm): 270 \_\_\_\_\_  
 Length (in): 10 <sup>5</sup>/<sub>8</sub> \_\_\_\_\_  
 Height (mm): 340 \_\_\_\_\_  
 Depth (mm): 290 \_\_\_\_\_  
 Height (in): 13 <sup>3</sup>/<sub>8</sub> \_\_\_\_\_  
 Depth (in): 11 <sup>1</sup>/<sub>16</sub> \_\_\_\_\_  
 Light Distribution: Omnidirectional \_\_\_\_\_  
 Weight (kg): 3 \_\_\_\_\_  
 Weight (lbs): 6.6 \_\_\_\_\_  
 Fixture Finish: WHI / PAL \_\_\_\_\_  
 Fixture Material: Metal \_\_\_\_\_

#### ELECTRICAL

Lamp Type: LED \_\_\_\_\_  
 Input Wattage (W): 4.2 \_\_\_\_\_  
 Total Output Wattage (W): 1.2 \_\_\_\_\_  
 Dimming: Non-Dimmable \_\_\_\_\_  
 Driver Included: Yes \_\_\_\_\_  
 Driver Location: Integrated \_\_\_\_\_  
 Driver Type: Constant Current - Universal \_\_\_\_\_  
 Driver Class: Class 2 \_\_\_\_\_  
 Input Voltage (V): 120 - 277 \_\_\_\_\_  
 Constant Current (MA): 350 \_\_\_\_\_  
 Upon Request: (Not included - see components) Remote: 0-10Vdc dimming / Phase dimming @120Vac only \_\_\_\_\_

#### LED

Number of LEDs: 1 \_\_\_\_\_  
 Color Temperature (°K): 2700 \_\_\_\_\_  
 Max. Delivered Lumen (lm): 376 \_\_\_\_\_  
 CRI: >90 CRI \_\_\_\_\_  
 Lamp Life (hrs): 50000 \_\_\_\_\_

#### OPTICAL

#### RATINGS AND CERTIFICATIONS

Certified By: Certified for North American Standards \_\_\_\_\_  
 IP rating: IP20 \_\_\_\_\_



250mm 9 13/16"

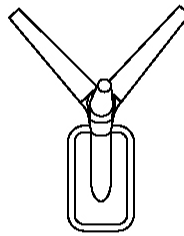

100mm 3 15/16"

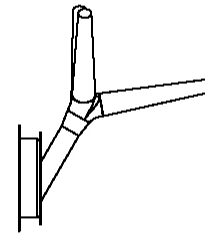

290mm 11 7/16"

340mm 13 3/8"

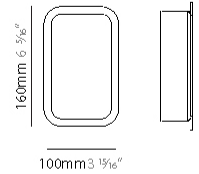

## SPARKS TRIPLE HEAD SURFACE

D103136-

PROJECT
TYPE
SPECIFIER
QUANTITY
DATE

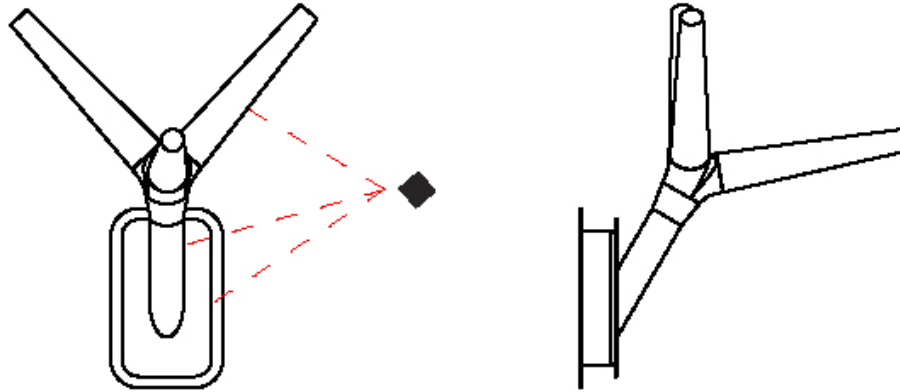

D

PROJECT	_____
TYPE	_____
SPECIFIER	_____
QUANTITY	_____
DATE	_____

## SPARKS 7 SURFACE

### D103142-

base number	LED Dimming	Finish Options
-------------	-------------	----------------

- To build a product code in our configurator select the specify button on the base model # product page
- To build a manual product code on this datasheet choose from the options listed below in blue font and add the suffix to the base model #

#### GENERAL

Series: Sparks
Subseries: Sparks 7
Brand: Quasar
Division: Design
Mounting Type: Surface
Mounting Location: Wall
Subcategory: Ambient

#### PHYSICAL

Shape: Abstract
Length (mm): 1100
Length (in): 43 <sup>5</sup> / <sub>16</sub>
Height (mm): 1800
Depth (mm): 900
Height (in): 70 <sup>7</sup> / <sub>8</sub>
Depth (in): 35 <sup>7</sup> / <sub>16</sub>
Light Distribution: Omnidirectional
Fixture Finish: WHI / PAL
Fixture Material: Metal

#### ELECTRICAL

Lamp Type: LED
Input Wattage (W): 32.2
Total Output Wattage (W): 22.4
Dimming: Non-Dimming / Phase Dimming (120Vac only) / 0-10V Dimming
Driver Included: Yes
Driver Location: Integrated
Driver Type: Constant Voltage - Universal
Driver Class: Class 2
Input Voltage (V): 120 - 277
Output Voltage (V): 24

#### LED

Number of LEDs: 7
Color Temperature (°K): 2700
Max. Delivered Lumen (lm): 2632
CRI: >90 CRI
Lamp Life (hrs): 50000

#### OPTICAL

#### RATINGS AND CERTIFICATIONS

Certified By: Certified for North American Standards
IP rating: IP20

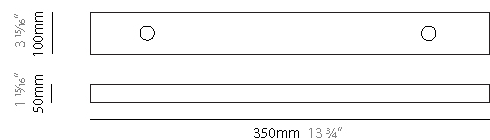
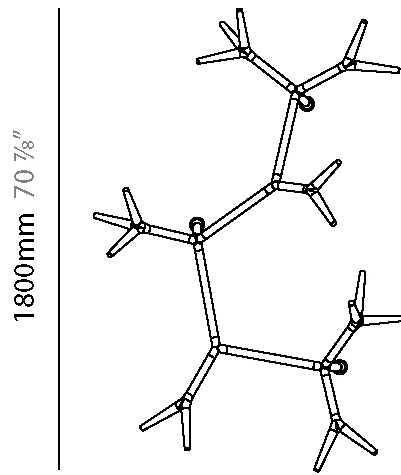
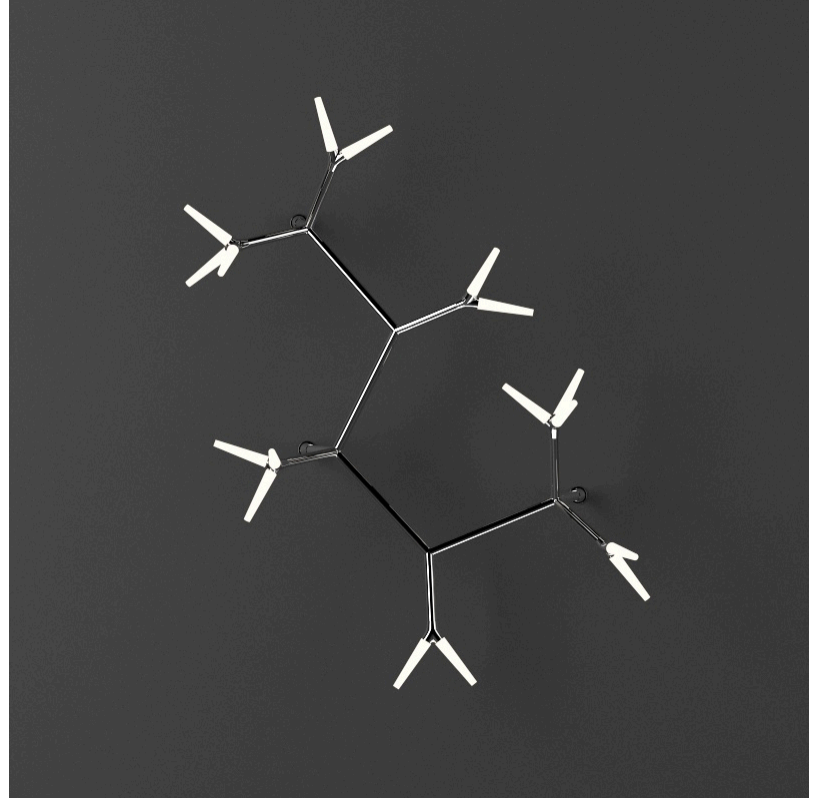

## SPARKS 7 SURFACE

D103142-

PROJECT
TYPE
SPECIFIER
QUANTITY
DATE

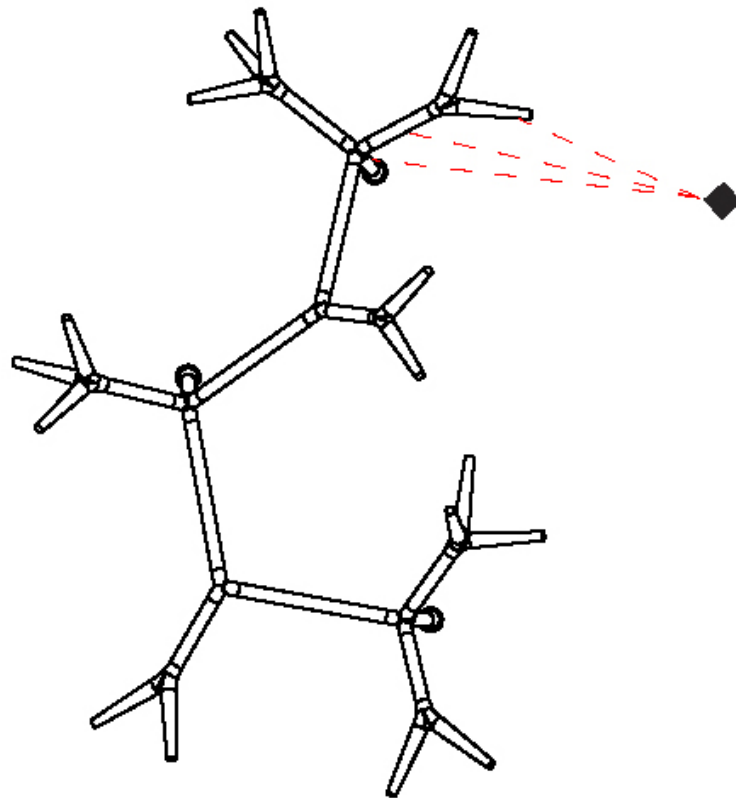

D

## SPARKS 9 SURFACE

**D103143-** \_\_\_\_\_ - \_\_\_\_\_

base number      LED Dimming      Finish Options

PROJECT	_____
TYPE	_____
SPECIFIER	_____
QUANTITY	_____
DATE	_____

- To build a product code in our configurator select the specify button on the base model # product page
- To build a manual product code on this datasheet choose from the options listed below in blue font and add the suffix to the base model #

### GENERAL

Series: Sparks  
 Subseries: Sparks 9  
 Brand: Quasar  
 Division: Design  
 Mounting Type: Surface  
 Mounting Location: Wall  
 Subcategory: Ambient

### PHYSICAL

Shape: Abstract  
 Length (mm): 1200  
 Length (in): 47 1/4  
 Height (mm): 2400  
 Depth (mm): 900  
 Height (in): 94 1/2  
 Depth (in): 35 7/16  
 Light Distribution: Omnidirectional  
 Fixture Finish: WHI / PAL  
 Fixture Material: Metal

### ELECTRICAL

Lamp Type: LED  
 Input Wattage (W): 41.4  
 Total Output Wattage (W): 28.8  
 Dimming: Non-Dimming / Phase Dimming (120Vac only) / 0-10V Dimming  
 Driver Included: Yes  
 Driver Location: Integrated  
 Driver Type: Constant Voltage - Universal  
 Driver Class: Class 2  
 Input Voltage (V): 120 - 277  
 Output Voltage (V): 24

### LED

Number of LEDs: 9  
 Color Temperature (°K): 2700  
 Max. Delivered Lumen (lm): 3384  
 CRI: >90 CRI  
 Lamp Life (hrs): 50000

### OPTICAL

### RATINGS AND CERTIFICATIONS

Certified By: Certified for North American Standards  
 IP rating: IP20

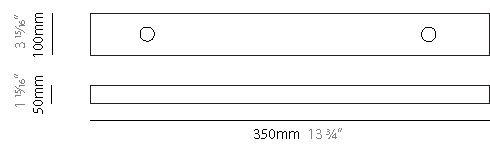
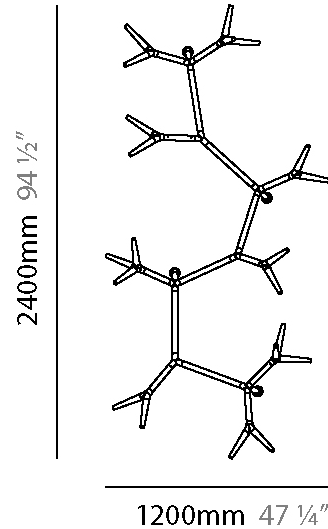
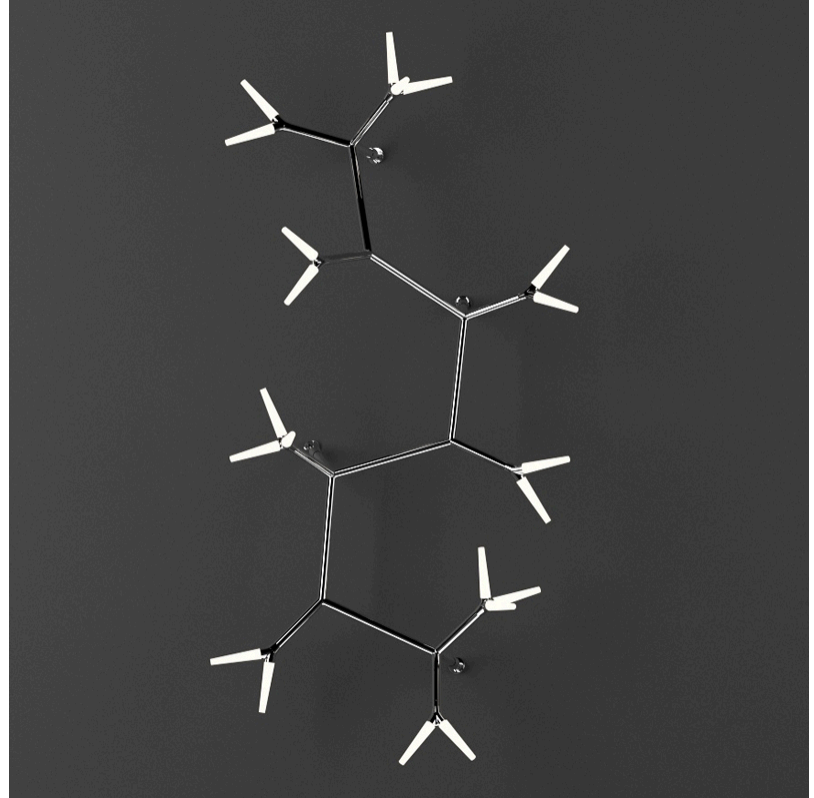

## SPARKS 9 SURFACE

D103143-

PROJECT

TYPE

SPECIFIER

QUANTITY

DATE

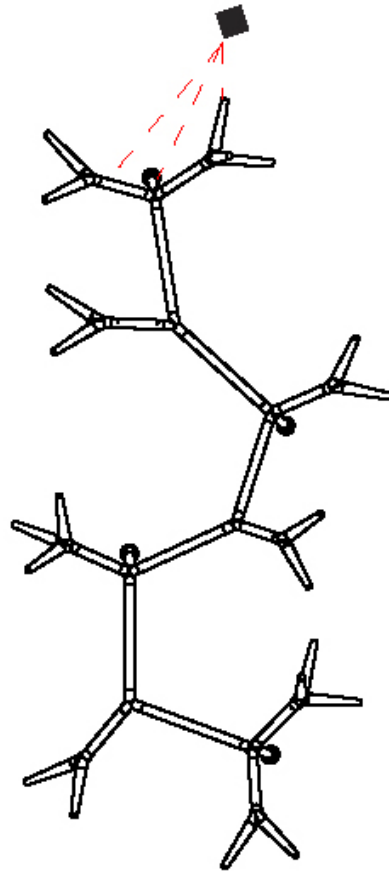

D



## SPARKS 11 SURFACE

### D103145-

base number      LED      Finish  
 Dimming      Options

- To build a product code in our configurator select the specify button on the base model # product page
- To build a manual product code on this datasheet choose from the options listed below in blue font and add the suffix to the base model #

#### GENERAL

Series: Sparks  
 Subseries: Sparks 11  
 Brand: Quasar  
 Division: Design  
 Mounting Type: Surface  
 Mounting Location: Wall  
 Subcategory: Ambient

#### PHYSICAL

Shape: Abstract  
 Length (mm): 1700  
 Length (in): 66 <sup>15</sup>/<sub>16</sub>  
 Height (mm): 2600  
 Depth (mm): 900  
 Height (in): 102 <sup>3</sup>/<sub>8</sub>  
 Depth (in): 35 <sup>7</sup>/<sub>16</sub>  
 Light Distribution: Omnidirectional  
 Fixture Finish: WHI / PAL  
 Fixture Material: Metal

#### ELECTRICAL

Lamp Type: LED  
 Input Wattage (W): 50.6  
 Total Output Wattage (W): 35.2  
 Dimming: Non-Dimming / Phase Dimming (120Vac only) / 0-10V Dimming  
 Driver Included: Yes  
 Driver Location: Integrated  
 Driver Type: Constant Voltage - Universal  
 Driver Class: Class 2  
 Input Voltage (V): 120 - 277  
 Output Voltage (V): 24

#### LED

Number of LEDs: 11  
 Color Temperature (°K): 2700  
 Max. Delivered Lumen (lm): 4136  
 CRI: >90 CRI  
 Lamp Life (hrs): 50000

#### OPTICAL

#### RATINGS AND CERTIFICATIONS

Certified By: Certified for North American Standards  
 IP rating: IP20

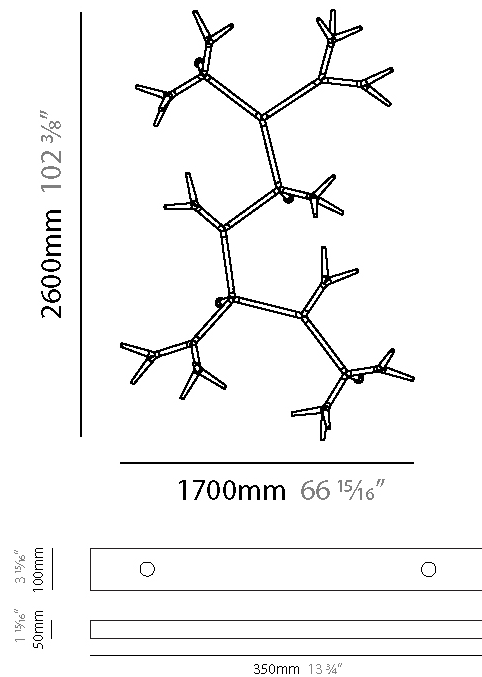
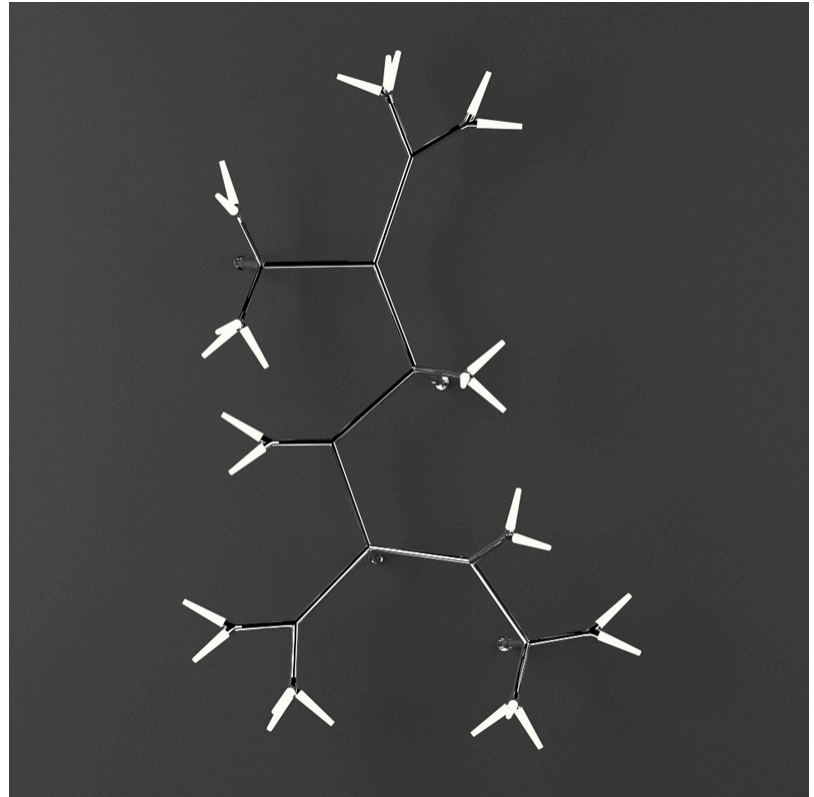

## SPARKS 11 SURFACE

D103145-

PROJECT

TYPE

SPECIFIER

QUANTITY

DATE

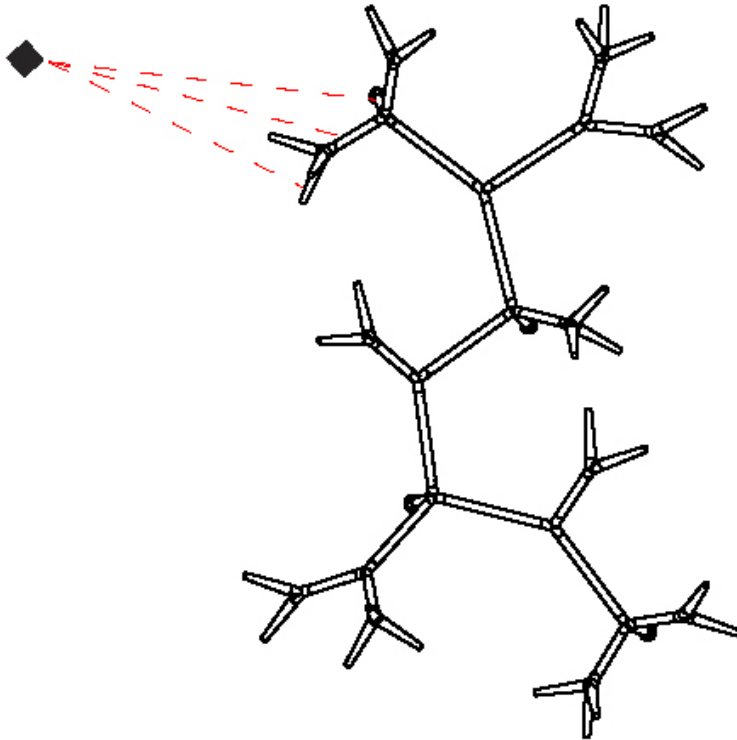

D

## SPARKS 15 SURFACE

### D103147-

base number      LED Dimming      Finish Options

PROJECT
TYPE
SPECIFIER
QUANTITY
DATE

- To build a product code in our configurator select the specify button on the base model # product page
- To build a manual product code on this datasheet choose from the options listed below in blue font and add the suffix to the base model #

#### GENERAL

Series: Sparks  
 Subseries: Sparks 15  
 Brand: Quasar  
 Division: Design  
 Mounting Type: Surface  
 Mounting Location: Wall  
 Subcategory: Ambient

#### PHYSICAL

Shape: Abstract  
 Length (mm): 1900  
 Length (in): 74 <sup>13</sup>/<sub>16</sub>  
 Height (mm): 3340  
 Depth (mm): 900  
 Height (in): 131 <sup>1</sup>/<sub>2</sub>  
 Depth (in): 35 <sup>7</sup>/<sub>16</sub>  
 Light Distribution: Omnidirectional  
 Weight (kg): 17  
 Weight (lbs): 37.48  
 Fixture Finish: WHI / PAL  
 Fixture Material: Metal

#### ELECTRICAL

Lamp Type: LED  
 Input Wattage (W): 69  
 Total Output Wattage (W): 48  
 Dimming: Non-Dimming / Phase Dimming (120Vac only) / 0-10V Dimming  
 Driver Included: Yes  
 Driver Location: Integrated  
 Driver Type: Constant Voltage - Universal  
 Driver Class: Class 2  
 Input Voltage (V): 120 - 277  
 Output Voltage (V): 24

#### LED

Number of LEDs: 15  
 Color Temperature (°K): 2700  
 Max. Delivered Lumen (lm): 5640  
 CRI: >90 CRI  
 Lamp Life (hrs): 50000

#### OPTICAL

#### RATINGS AND CERTIFICATIONS

Certified By: Certified for North American Standards  
 IP rating: IP20

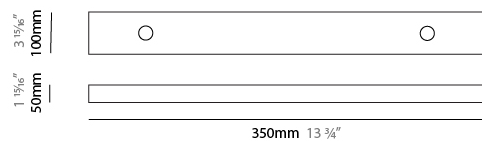
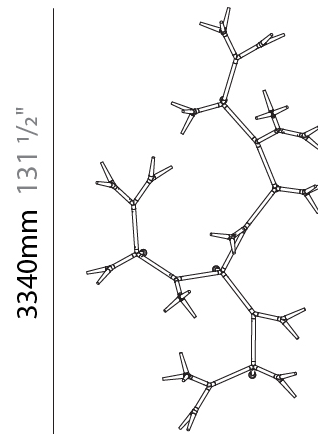
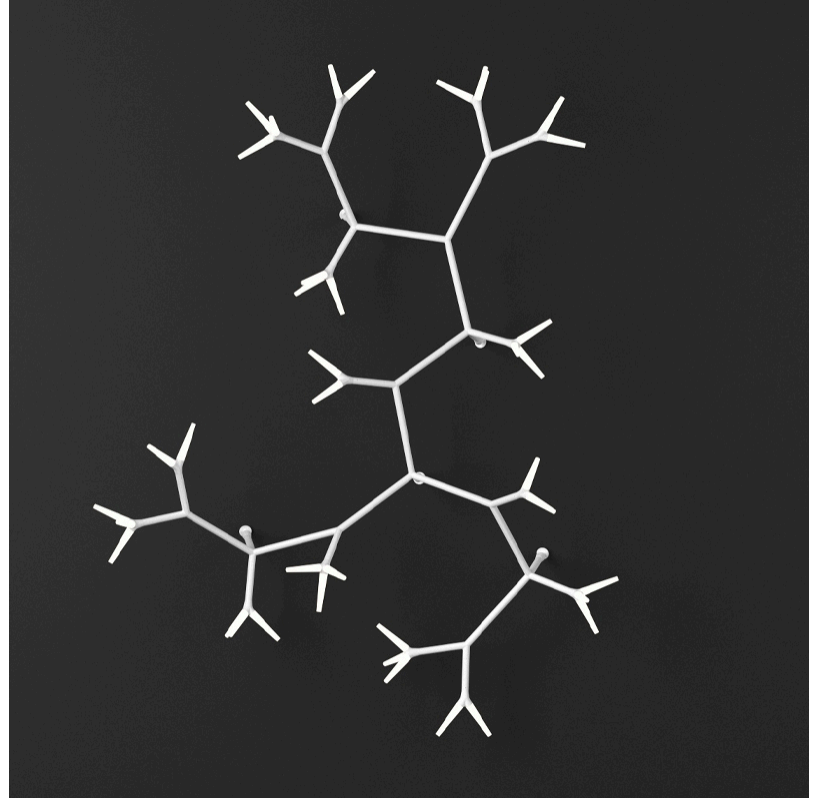

D103147-

PROJECT

TYPE

SPECIFIER

QUANTITY

DATE

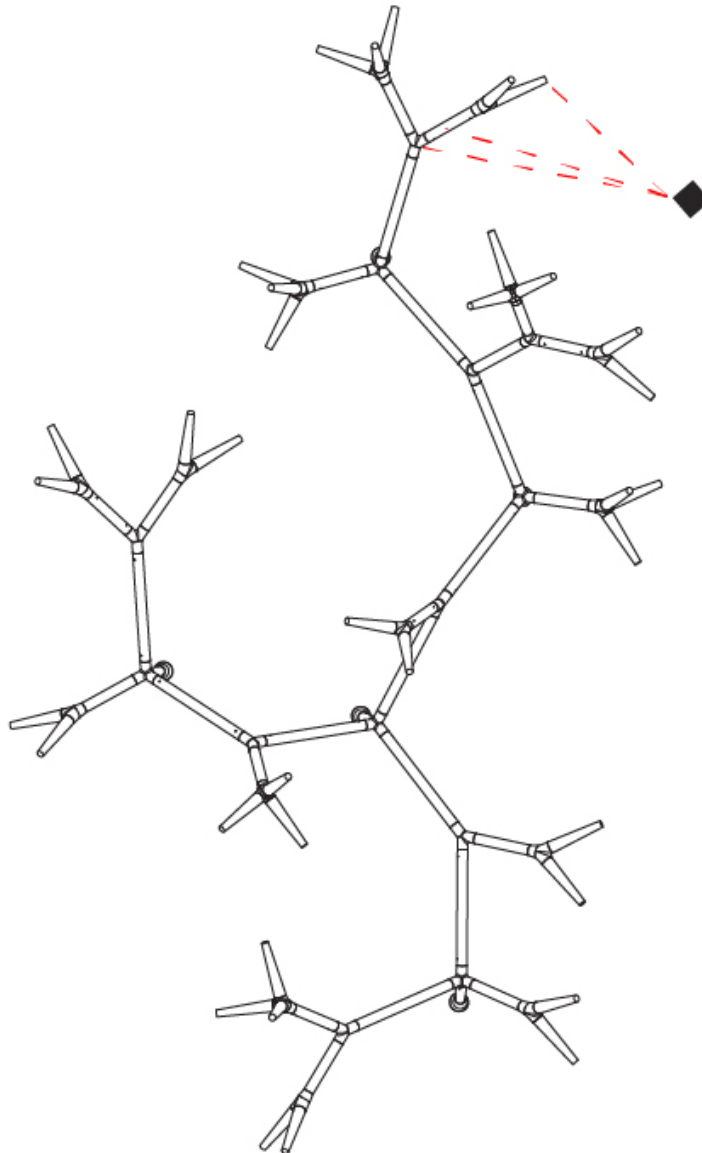

D

## SPARKS 17 SURFACE

### D103148-

base number LED Dimming Finish Options

- To build a product code in our configurator select the specify button on the base model # product page
- To build a manual product code on this datasheet choose from the options listed below in blue font and add the suffix to the base model #

#### GENERAL

Series: Sparks  
 Subseries: Sparks 17  
 Brand: Quasar  
 Division: Design  
 Mounting Type: Surface  
 Mounting Location: Wall  
 Subcategory: Ambient

#### PHYSICAL

Shape: Abstract  
 Length (mm): 2590  
 Length (in): 101 <sup>15</sup>/<sub>16</sub>  
 Height (mm): 3250  
 Depth (mm): 900  
 Height (in): 127 <sup>15</sup>/<sub>16</sub>  
 Depth (in): 35 <sup>7</sup>/<sub>16</sub>  
 Light Distribution: Omnidirectional  
 Weight (kg): 21  
 Weight (lbs): 46.30  
 Fixture Finish: WHI / PAL  
 Fixture Material: Metal

#### ELECTRICAL

Lamp Type: LED  
 Input Wattage (W): 78.2  
 Total Output Wattage (W): 54.4  
 Dimming: Non-Dimming / Phase Dimming (120Vac only) / 0-10V Dimming  
 Driver Included: Yes  
 Driver Location: Integrated  
 Driver Type: Constant Voltage - Universal  
 Driver Class: Class 2  
 Input Voltage (V): 120 - 277  
 Output Voltage (V): 24

#### LED

Number of LEDs: 17  
 Color Temperature (°K): 2700  
 Max. Delivered Lumen (lm): 6392  
 CRI: >90 CRI  
 Lamp Life (hrs): 50000

#### OPTICAL

#### RATINGS AND CERTIFICATIONS

Certified By: Certified for North American Standards  
 IP rating: IP20

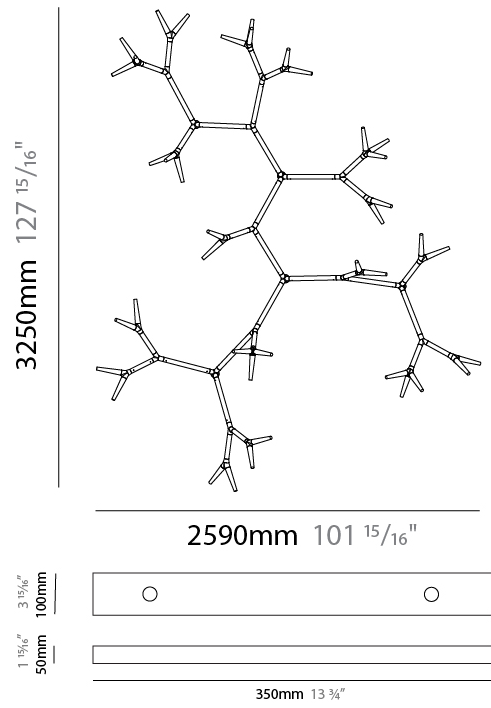
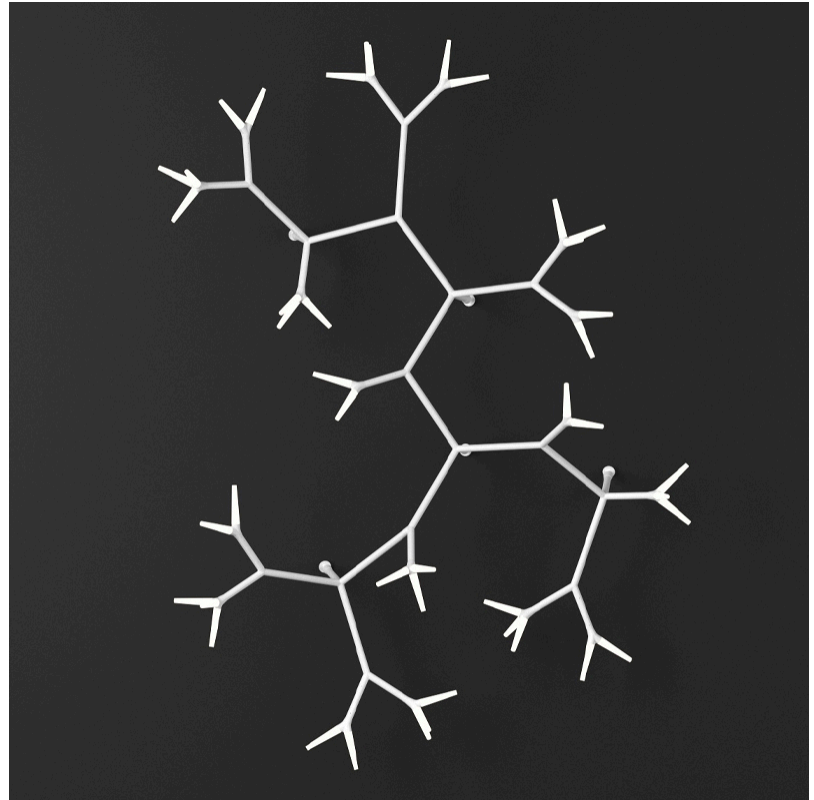

## SPARKS 17 SURFACE

D103148-

PROJECT

TYPE

SPECIFIER

QUANTITY

DATE

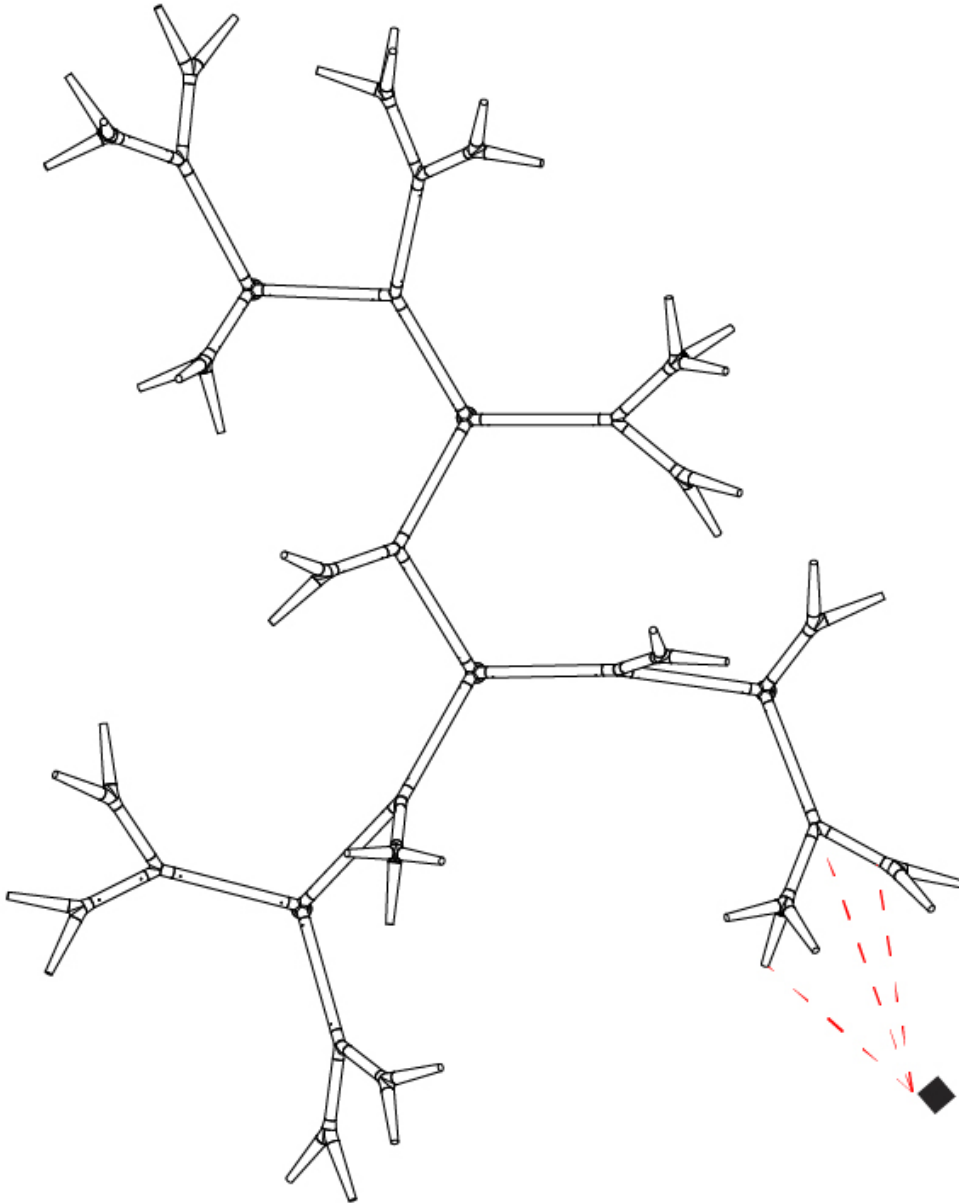

D

PROJECT	
TYPE	
SPECIFIER	
QUANTITY	
DATE	

## SPARKS 19 SURFACE

### D103149-

base number	LED Dimming	Finish Options
-------------	-------------	----------------

- To build a product code in our configurator select the specify button on the base model # product page
- To build a manual product code on this datasheet choose from the options listed below in blue font and add the suffix to the base model #

#### GENERAL

Series: Sparks
Subseries: Sparks 19
Brand: Quasar
Division: Design
Mounting Type: Surface
Mounting Location: Wall
Subcategory: Ambient

#### PHYSICAL

Shape: Abstract
Length (mm): 1880
Length (in): 74
Height (mm): 5300
Depth (mm): 900
Height (in): 208 <sup>11</sup> / <sub>16</sub>
Depth (in): 35 <sup>7</sup> / <sub>16</sub>
Light Distribution: Omnidirectional
Weight (kg): 24
Weight (lbs): 52.91
Fixture Finish: WHI / PAL
Fixture Material: Metal

#### ELECTRICAL

Lamp Type: LED
Input Wattage (W): 87.4
Total Output Wattage (W): 60.8
Dimming: 0-10V Dimming / Phase Dimming (120Vac Only)
Driver Included: Yes
Driver Location: Integrated
Driver Type: Constant Voltage - Universal
Driver Class: Class 2
Input Voltage (V): 120 - 277
Output Voltage (V): 24

#### LED

Number of LEDs: 19
Color Temperature (°K): 2700
Max. Delivered Lumen (lm): 7144
CRI: >90 CRI
Lamp Life (hrs): 50000

#### OPTICAL

#### RATINGS AND CERTIFICATIONS

Certified By: Certified for North American Standards
IP rating: IP20

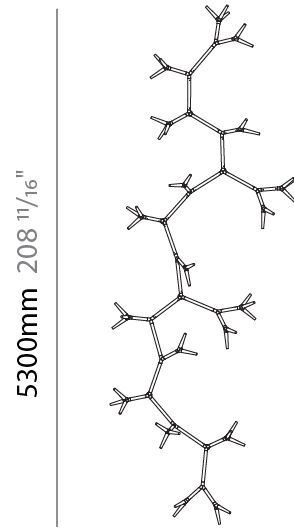
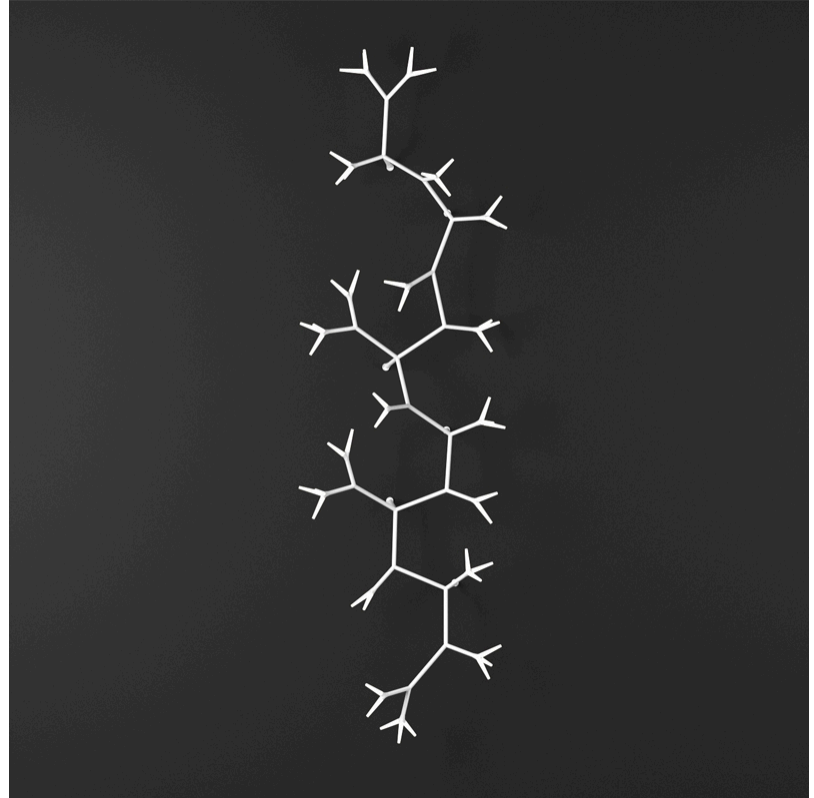

1880mm 74"

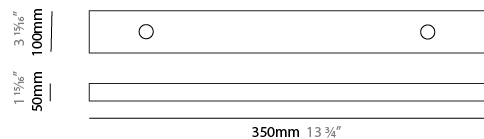

D103149-

PROJECT

TYPE

SPECIFIER

QUANTITY

DATE

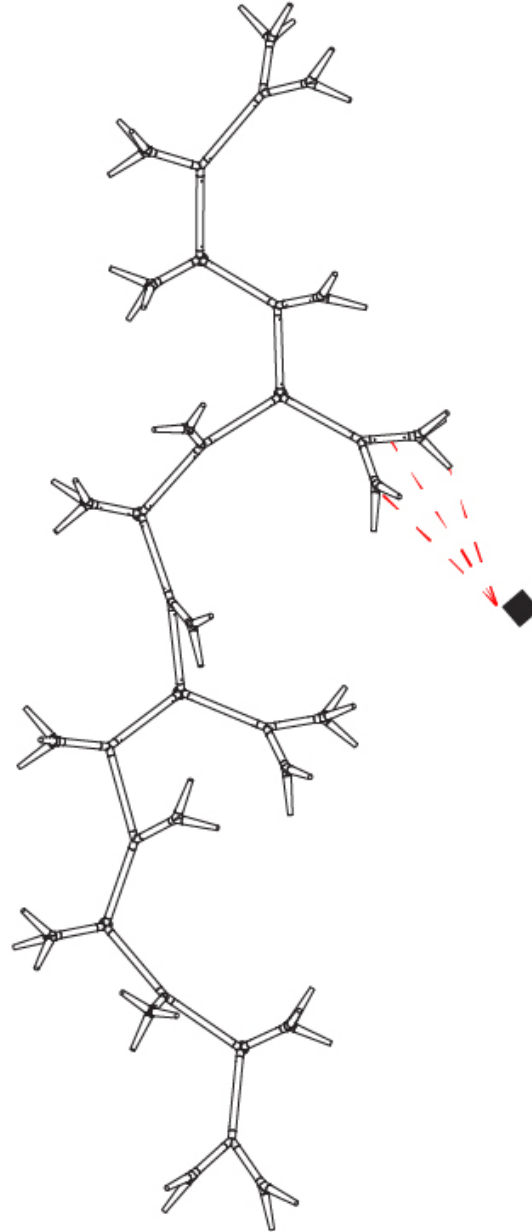

D



## SPARKS

### COLOR FINISH CHART

PROJECT \_\_\_\_\_

TYPE \_\_\_\_\_

SPECIFIER \_\_\_\_\_

QUANTITY \_\_\_\_\_

DATE \_\_\_\_\_

#### Fixture Finish

White - WHI



Polished Alumimum - PAL

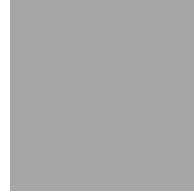

**Digital:** Not all screens are calibrated the same, and therefore, colors will appear differently between screens.

**Physical:** When texture is involved, there will be variations in color, character and tone within a product series and between product families.



PROJECT	
TYPE	
SPECIFIER	
QUANTITY	
DATE	

### LEGEND

floor-mounted	pivotal	special LED (upon request) RGB, RGBW, tunable, gold+, meat+, art+, fashion+
wall and ceiling: recessed and surface mounted	rotating	warm dim / natural dimming LED
ceiling-mounted and wall-mounted	illuminate tilted	rechargeable battery powered
wall-mounted	color of suspension cable	fixture with natural vivid LED (upon request)
omni-directional light distribution	length of suspension cable	color rendering index
direct light distribution	reflector degree selection	color temperature
direct/indirect light distribution	super spot	lumen (luminous flux)
indirect light distribution	lens	efficacy (lumens per watt)
asymmetric light distribution	lens pack	Unified Glare Rating (UGR) range from 5-40
aura light distribution	shine ring	marine grade (AISI 316 stainless steel)
round wall or ceiling cut-out	integrated shine ring with diffuser	walk on
square wall or ceiling cut-out	free individual colors 01-29	drive on
the supplied jig specifies the cutout dimensions	individual colors: 00 (free of charge), 01-25 (extra charge)	Dark Sky Compliance
minimum distance (meters) lamp - object	luminaire part to be colored (F1)	Americans with Disabilities Act (less than 4" off the wall located between 27"-84" from floor)
recessed depth	luminaire part to be colored (F2)	lamp protected against explosion
ceiling thickness in mm	luminaire part to be colored (F3)	blown glass using traditional methods by master glass blower
ceiling thickness selection	luminaire part to be colored (F4)	acoustic material
dimmable DP (phase), DV (0-10V), DD (dali), DS (step-dim)	luminaire part to be colored (F5)	protection class I, protection insulation
included or excluded LED driver/transformer/control gear	color of 3-circuit adaptor	protection class II, protection insulation
separately switchable	indirect diffuser	ETL Certified to UL and CSA Standards
sensor	direct diffuser	UL Certified to UL and CSA Standards
remote control	ball-proof (upon request)	CSA Certified to UL and CSA Standards
available upon request	accessory	Certified for North American Standards

### IP RATING

IP20	protected against ingress of solid bodies greater than 12.5mm (finger)
IP33	protected against ingress of solid bodies greater than 2.5mm protected against sprays of water up to 60 degrees from the vertical (rain)
IP40	protected against ingress of solid bodies greater than 1mm (wire) no protection against the ingress of moisture
IP43	protected against ingress of solid bodies greater than 1mm (wire) protected against sprays of water up to 60 degrees from the vertical (rain)
IP44	protected against ingress of solid bodies greater than 1mm (wire) protected against water splashed from all directions
IP54	protected against limited ingress of dust (wet rooms/covered outdoor areas) protected against water splashed from all directions
IP65	protected against ingress of dust protected against jets of water
IP66	protected against ingress of dust protected against powerful jets of water or heavy seas
IP67	protected against ingress of dust protected against immersion of water between 15cm - 1m for 30 minutes
IP68	protected against ingress of dust protected against immersion of water under pressure for long periods

### IK RATING

IK01	protected against 0.14 joules impact (equivalent to 0.25kg mass dropped from 56mm above the surface)
IK02	protected against 0.2 joules impact (equivalent to 0.25kg mass dropped from 80mm above the surface)
IK03	protected against 0.35 joules impact (equivalent to 0.25kg mass dropped from 140mm above the surface)
IK04	protected against 0.5 joules impact (equivalent to 0.25kg mass dropped from 200mm above the surface)
IK05	protected against 0.7 joules impact (equivalent to 0.25kg mass dropped from 280mm above the surface)
IK06	protected against 1 joules impact (equivalent to 0.25kg mass dropped from 400mm above the surface)
IK07	protected against 2 joules impact (equivalent to 0.5kg mass dropped from 400mm above the surface)
IK08	protected against 5 joules impact (equivalent to 1.7kg mass dropped from 300mm above the surface)
IK09	protected against 10 joules impact (equivalent to 5.0kg mass dropped from 200mm above the surface)
IK10	protected against 20 joules impact (equivalent to 5.0kg mass dropped from 400mm above the surface)